

temperature

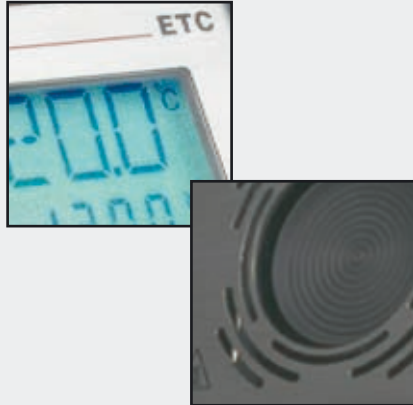

Temperature ranges

ETC-125 A	-10 to 125°C / 14 to 257°F
ETC-400 A	28 to 400°C / 82 to 752°F
ETC-400 R	28 to 400°C / 82 to 752°F

Fast calibration saves money

Heats up as quickly as 100°C / 212°F per minute and stabilizes in just 3 minutes. Completes a 2-point test in less than 10 minutes

Extreme flexibility

The small size makes it perfect to store in a tool box and to check temperature sensors that are difficult to access

Fully-featured despite the small size

The multi-information display shows actual and set temperatures, a stability indicator, and a stability countdown timer

Timesaving features

Fast one-key-one-function access to set the temperature and the auto-stepping function

Documentation made easy

RS232 communication interface and JOFRACAL calibration software are part of the ready-to-use standard delivery

Easy IR calibration

Standard delivery of the ETC-400 R includes JOFRA IR-LAB software enabling the user to calibrate IR thermometers with a fixed emission factor setting

Complete marine program

Part of a complete program of marine approved temperature, pressure and signal calibrators; including temperature sensors
See more at www.jofra.com

ISO 9001 Manufacturer

JOFRA™ ETC Series

Easy Temperature Calibrator

With Calibrator ETC-400 R for infrared thermometers including IR-LAB software.

This may be the fastest dry-block calibrator in the world

Heats up by up to 100°C / 212°F per minute and completes a full dual-point test in less than 10 minutes, including stability time; timesavings at your fingertips! The ETC- series is designed for field testing of temperature measurement devices.

The small size and light weight make it a perfect instrument to verify sensors in difficult to reach places.

All JOFRA ETC units have many of the same useful and timesaving features offered in the more advanced JOFRA dry-block series.



PRODUCT DESCRIPTION

Designed for people who perform tests and verifications of temperature sensing devices in the field. This instrument is ideal when time is a critical factor and the highest accuracy is not a critical factor.

Reduced size and weight are important considerations because the unit is able to fit into a tool box or instrument carrying case and can be used for sensors that are difficult to access.

One-key-one-function user interface provides immediate access to setting the temperature and the auto-step timesaving function. There is no need for manipulation of sophisticated menus.

The Stability indicator provides audible and visual prompts when the temperature is stable. This function also includes a 3 minute countdown before the stable condition.

Stainless steel and rubber side panels make the instrument suitable for many years of faithful duty in an industrial environment.

AMETEK®
CALIBRATION INSTRUMENTS

ETC-400 R for infrared thermometers

The ETC-400 R is designed for optimum speed in connection with calibration of infrared thermometers. The 36 mm target provides the optimum size for reliable calibration of infrared thermometers in the process industry as it is designed for high accuracy and long-term stability while maintaining speed.

With regard to the coating of the target it has been especially designed for space technology applications, which secure long time performance under high temperature influence. In combination with the shape of the target it ensures the emissivity of 0.96.

If higher accuracy is required, and for recalibration, a 3 mm external JOFRA STS reference probe can be placed under the surface of the target.

Find ordering information for the STS-103 B reference sensor at page 7.



Super fast heating - ETC-400 A dry-block

The ETC-400 A is designed for optimum speed. The heating block is built around a highly efficient heating element. The insertion holes for the temperature device under test are located around this element. To reduce mass and increase effectiveness, there is no removable insertion tube; the holes are drilled directly into the block. The minimal mass offers an extremely fast heating and cooling time. The different layouts also make it possible to use an external JOFRA STS reference probe during the calibration.

Choose the combination of holes that best suits your needs from our various design combinations.

If your application requires a dry-block that can handle large sensors or more than one sensor at a time, we offer several other JOFRA dry-block calibrators that can meet your needs.

Cooling and heating - ETC-125 A dry-block

The ETC-125 A is a simple yet effective tool for verifying temperature instruments that also require references below ambient temperatures: e.g. air-conditioning and cold counters. The predrilled holes allow the use of an insertion tube in the largest bore. This increases the flexibility to match many sensor-under-test sizes.

Easy-to-use, intuitive operation

All instrument controls are accessed directly from the front panel. The main functions on the ETC series are designed with one-key-one-function logic. This means that there are no difficult multiple keystrokes to remember to access primary functions. The easy-to-read, backlit display features dedicated icons, which help in identifying instrument conditions and operational steps.



Set temperature

The "Up" and "Down" arrow keys allow the user to set the exact temperature desired with a resolution of 0.1°C or °F.

Stability indicator

The bold checkmark on the display indicates that the calibrator has reached the desired set temperature and is stable. The operator may change the stability criteria and establish a greater level of confidence in the calibration results as desired. A convenient countdown timer is activated three minutes before the unit reaches stability. This prompts you to be prepared to record results.

Auto-stepping

This feature saves time. The operator may stay in the control room, or another remote location, monitoring the output from the sensor-under-test while the ETC-series calibrator is placed in the process and automatically changes the temperature using a programmed step value and rate. Up to 9 different temperature steps may be programmed, including the hold time for each step. This feature is also ideal for burning-in new sensors prior to installation; this minimizes initial drift and allows for initial testing. It is also useful for testing temperature data loggers.

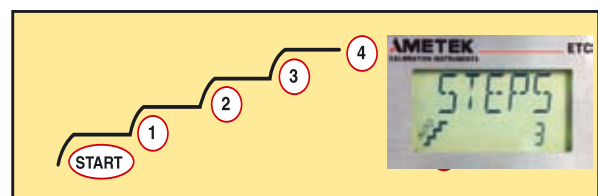

Maximum temperature

From the setup menu, you can select a lower maximum temperature limit for the calibrator. This function prevents damage to the sensor-under-test caused by the application of excessive temperatures.

Instrument setups

The ETC-series stores the complete instrument setup, including: engineering units, stability criteria, resolution, auto-step settings, and maximum temperature.

Re-calibration/adjustments made easy

The ETC- series has a very easy and straightforward procedure for re-calibration/adjustment. There is no need for a screwdriver or PC software. The only thing you need is a reliable reference thermometer.

Place the probe in the calibrator and follow the instructions on the display.

JOFRA IR-LAB software for the ETC-400 R

As an extra feature the ETC-400 R will be delivered with a small mathematical program, which will constitute a powerful tool together with the calibrator. The program enables you to calculate at which temperatures you need to calibrate, if your IR thermometer is either locked to a fixed emission factor or if you just want to calibrate your thermometer at a certain emission factor. The program facilitates the whole issue of correcting settings of emission factors and temperatures.

The calibration surface of the JOFRA ETC-400 R IR calibrator has an emission factor of 0,96. If your IR-thermometer is using a different emission factor than 0.96, the result will be a faulty temperature reading on your IR thermometer. However if your IR thermometer is using an emission factor of 0.95 or 0.98 – a helpful diagram is part of the standard delivery.

Example: Your thermometer is locked to an emission factor of 0,98 and you have set the JOFRA ETC-400 R to 300°C. The diagram indicates that 3,9°C must be subtracted from the calibrator temperature, to obtain the “true” IR thermometer reading (296,1°C).

If you are working with IR thermometers where the emission factor is different than 0.95, 0.96 or 0.98, or other parameters differ from “standard”, use the PC program JOFRA IR-Lab. The JOFRA IR-Lab program allows you to type in various emission factors, in order to get a “true” temperature readout on your thermometer or the other way around - what is the true surface temperature of the calibrator. But the IR-Lab will do more than that; it allows you to calculate “true” temperatures in simulated surroundings that approximate your actual test environments.

Calibration of up to 24 sensors with JOFRA ASM

Using the JOFRA ETC series together with the ASM Advanced Signal Multi-scanner offers a great time-saving automatic solution to calibrate multiple temperature sensors at the same time.

The ASM series is an eight channel scanner controlled by JOFRACAL software on a PC. Up to 3 ASM units can be stacked to calibrate up to 24 sensors at the same time. It can handle signals from 2-, 3- and 4 wire RTD's, TC's, transmitters, thermistors, temperature switches and voltage.

Please also see more in specification sheet SS-CP-2360, which can be found at www.jofra.com



Simplified calibration documentation

All ETC series calibrators are provided with the JOFRACAL calibration software. This software allows the user to customize his or her calibration routines. The software is easy-to-use so you do not have to be a programmer to configure your own calibration procedures. The software features prompts, menus, and help functions that guide you through the configuration process.

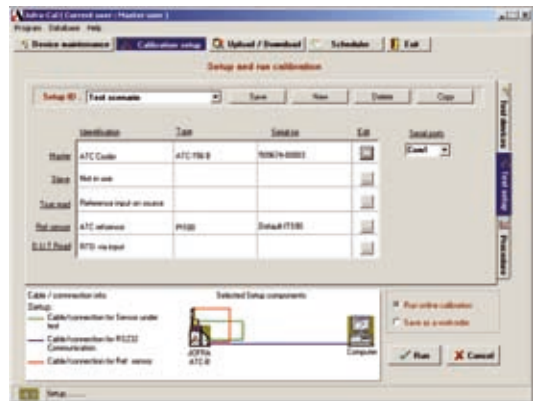

The JOFRACAL calibration software supports automatic calibration for all JOFRA dry-block calibrators equipped with an RS232 serial data interface including the JOFRA DT1050 digital thermometer, the JOFRA DTI-1000 digital thermometer and the JOFRA ASM Multi-scanner.

For semi-automatic calibrations, the software also supports liquid baths, ice points, or other dry-block heating and cooling sources. Using the software's "SCENARIO" function allows for combining instruments in virtually any configuration.

Once all calibrations are completed, the data may be uploaded to the JOFRACAL calibration software for post-processing and printing of certificates. The calibration data collected may be stored on the personal computer for later recall or analysis.

The JOFRACAL temperature calibration software may be downloaded from our web-page www.jofra.com.

Please also see more about JOFRACAL calibration software in specification sheet SS-CP-2510, which can be found at www.jofra.com



SPECIFICATIONS

Temperature range @ ambient temp. 23°C / 73°F

ETC-125 A	
Maximum.....	125°C / 257°F
Minimum @ ambient temp. 0°C / 32°F	-18°C / -0°F
Minimum @ ambient temp. 23°C / 73°F	-10°C / -14°F
Minimum @ ambient temp. 40°C / 104°F	6°C / 43°F
ETC-400 A	28 to 400°C / 82 to 752°F@ 23°C
ETC-400 R	28 to 400°C / 82 to 752°F@ 23°C

Resolution (user-selectable)

Selectable	1° or 0.1°
------------------	------------

Heating time

ETC-125 A	
-10 to 23°C / 14 to 73°F	3 minutes
23 to 100°C / 73 to 212°F	11 minutes
100 to 125°C / 212 to 257°F	7 minutes

ETC-400 A / R

28 to 200°C / 82 to 392°F	2 minutes
200 to 400°C / 392 to 752°F	3 minutes

Cooling time

ETC-125 A	
125 to 100°C / 257 to 212°F	1 minute
100 to 0°C / 212 to 32°F	17 minutes
0 to -10°C / 32 to 14°F	14 minutes

ETC-400 A

400 to 200°C / 752 to 392°F	6 minutes
200 to 50°C / 392 to 122°F.....	15 minutes

ETC-400 R

400 to 200°C / 752 to 392°F	9 minutes
200 to 50°C / 392 to 122°F.....	24 minutes

Stability

ETC-125 A	±0.05°C / ±0.09°F
ETC-400 A	±0.15°C / ±0.27°F
ETC-400 R	±0.3°C / ±0.54°F

Measured after the stability indicator has been on for 10 minutes.
Measuring time is 30 minutes.

Time to stability (approximate)

All models	3 minutes
------------------	-----------

Accuracy

ETC-125 A	±0.5°C / ±0.9°F 1)
ETC-400 A	±0.5°C / ±0.9°F 1)
ETC-400 R	±0.5°C / ±0.9°F 2)
ETC-400 R incl. emissivity	
.....	±0.4% rdg ±1°C / ±0.4% rdg. ±1.8°F

- 1) Specification when using the internal reference. (Load 4 mm OD reference probe in the center of the insert).
- 2) Specification when using the internal reference. (Load 3 mm OD reference probe).

Immersion depth

ETC-125 A (insulation included)	110 mm / 4.3 in
ETC-400 A	105 mm / 4.1 in

Mains specifications

Voltage ETC-125 A.....	Multivoltage 115VAC and 230VAC
.....	115V(90-132) and 230V(180-264)
Voltage ETC-400 A/R	115V(90-127) or 230V(180-254)
Frequency ETC-125 A.....	47 - 63 Hz
Frequency ETC-400 A/R	45 - 65 Hz
Power consumption (max.) ETC-125 A.....	75 VA
Power consumption (max.) ETC-400 A/R	350 W

JOFRACAL software

Minimum hardware requirements for JOFRACAL calibration software.

- INTEL™ 486 processor (PENTIUM™ 800 MHz recommended)
- 32 MB RAM (64 MB recommended)
- 80 MB free disk space on hard disk prior to installation
- Standard VGA (800 x 600, 16 colors) compatible screen (1024 x 786, 256 colors recommended)
- CD-ROM drive for installation of the program
- 1 free RS232 serial port



KEY FEATURE TABLE

Auto stepping

Programmable.....Up to 9 steps
Dwell time on each step..... Programmable

Multi-information display

Stability indicator.....Clear checkmark
Countdown timer before stable..... 3 minutes
Temperature.....SET and READ simultaneously
Alphanumeric messages..... Yes
Calibration status icons..... Yes

Training mode (heating/cooling block disabled)

Simulation of all functions..... Yes
Simulating heating and cooling..... Approx. 100° per minute

Service facilities

Adjustment of the unit from the keypad..... Yes
Self explaining guide in display..... Yes
Other information:
Display serial number, software revision level, and last calibration date

Setup facilities

Stability criteria:
Extra time before "stable indication" is shown
Display resolution.....1° or 1°C/°F
Temperature units..... °C or °F
Slope rate.....0.1 to 9.9°/minute
Maximum temperature.....Any value within range

STANDARD DELIVERY

- JOFRA ETC dry-block calibrator
- Traceable calibration certificate - temperature performance
- JOFRACAL calibration software
- User and reference manual
- Mains power cable
- Shoulder strap
- RS232 cable
- 1 x predrilled insertion tube (ETC-125 A only)
- Tool for insertion tubes (ETC-125 A only)
- Carrying case (ETC-400 R only) 1)
- JOFRA IR-LAB calibration software (ETC-400 R only)
- Emissivity table (ETC-400 R only)

1) The ETC-400 R is delivered with a carrying case as standard because it is important to keep dust away from the surface of the target on the ETC-400 R. The reason being that a clean surface is important to keep the emissivity and thereby the accuracy. The carrying case is optional for ETC-400 A and ETC-125 A.

PHYSICAL SPECIFICATIONS

Instrument dimensions

ETC-125 A, ETC-400 A and ETC-400 R
L x W x H:..... 172 x 72 x 182 mm / 6.8 x 2.8 x 7.2 in

Instrument weight

ETC-125 A.....1.8 kg / 3.9 lb
ETC-400 A.....1.6 kg / 3.5 lb
ETC-400 R.....1.7 kg / 3.7 lb

Shipping (including shipping cargo box)

ETC-125 A:..... 3.0 kg / 6.6 lb
ETC-400 A:..... 2.8 kg / 6.2 lb
ETC-400 R..... 4.5 kg / 9.9 lb

Size, L x W x H:

ETC-125 A / 400 A: ..345 x 235 x 135 mm / 13.6 x 9.3 x 5.3 in
ETC-400 R..... 425 x 320 x 165 mm / 16.7 x 12.5 x 6.5 in

Miscellaneous

Serial data interface..... RS232
Operating temperature..... 0 to 40°C / 32 to 104°F
Storage temperature..... -20 to 50°C / -4 to 122°F
Humidity..... 0 to 90% RH
Protection class..... IP-10
DNV Marine Approval, Certificate no.:..... A-9557



ACCESSORIES

Part No.	Description
123939	5 x undrilled insertion tubes for ETC-125 A
123938	8 mm insertion tube for ETC-125 A
124045	3/8 in insertion tube for ETC-125 A

Carrying case (Optional for ETC-125 / 400 A) - 124094

The optional protective carrying case ensures safe transportation and storage of the instrument and all associated equipment.



INSERTS FOR ETC SERIES



**ETC-125 A
Type 01**



**ETC-125 A
Type 02**

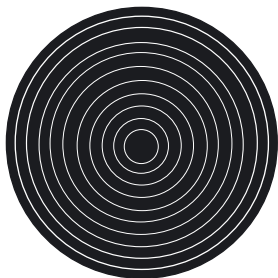

**ETC-400 R
Type 51
36 mm (1.4 in) target**

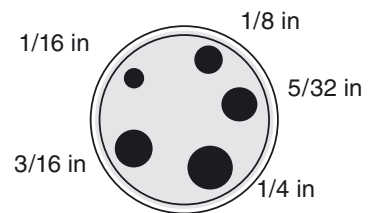

**ETC-400 A
Type 11, Imperial**

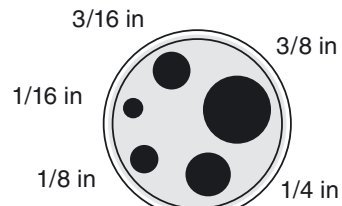

**ETC-400 A
Type 12, Imperial**

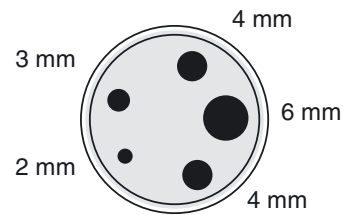

**ETC-400 A
Type 21, Metric**



JOFRA™ STS-103 B

It is not easy to make a good quality reference probe. The main requirement of a reference probe is stability. This means minimal drift as a function of operating time at the actual temperature. The less the probe drifts, the lower the measurement uncertainty.

JOFRA has designed a special 3 mm STS reference sensor, the STS-103 B especially for the ETC-400 R calibrator. The sensor can be used as a reference sensor when a higher accuracy is required or for recalibration of the ETC-400 R. Due to the small immersion depth requirement of the sensor it can be placed under the surface of the target.

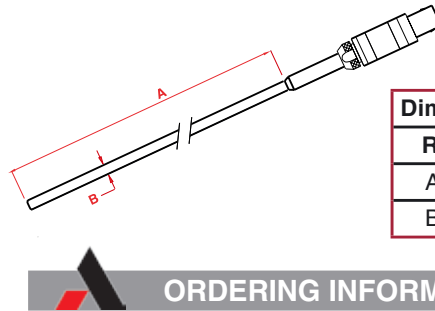

Dimensions		
Ref.	mm	inch
A	150	5.91
B	3	0.12

SPECIFICATIONS STS-103 B

Temperature range
All probes -50 to 400°C / -58 to 752°F

Accuracy
Hysteresis¹⁾ @0°C / 32°F.....0.01°C / 0.02°F
Long term stability ²⁾ @0°C / 32°F.....typ. 0.014°C / 0.025°F
Repeatability ¹⁾.....0.005°C / 0.009°F

Note 1: When used in the range -45 to 400°C / -49 to 752°F.
Note 2: When exposed to 400°C / 752°F for 100 h. Stability will depend on actual use of the sensor.

Sensing element
Type.....Pt100
Nominal resistance@0°C / 32°F.....100 Ω
Length6 mm / 0.2 in
Temperature coefficientα₁₀₀=0.00385 1/°C

Minimum immersion depth
STS-103 B (3 mm / 0.12 in):40 mm / 1.6 in

Self-heating effect
0.06°C/mW / 0.108°F/mW

Response time
τ_{0.5} (50%).....5 seconds
τ_{0.9} (90%).....15 seconds

Liquid in motion v=0.4m/s.

Electrical connections
Cable4 wire + shield
Connection.....LEMO goldplated

Insulation resistance
@ 23°C / 73°F100 Gohm
@ 400°C / 752°F70 Mohm

Outer tube
Inconel 600

Operating conditions
(Probe, connection, and cable)Max. 70°C / 158°F
Storage temperature-20 to 70°C / -4 to 158°F
Humidity0 to 90% RH
Protection class (connectors)DIN 40050 IP-50

Shipping dimensions - including carrying case
L x W x H.....750 x 140 x 140 mm / 29.5 x 5.5 x 5.5 in

Shipping weight including packing
STS-103 B2 kg / 4.4 lb

ORDERING INFORMATION STS-103 B

Order no.	Description
STS103	Base model number Pt100 reference probe, 0°C to 400°C
B	Diameter of the probe Overall diameter 3 mm
150	Shape and length Straight probe, 150 mm (5.9 in)
A B C	Cable length and termination A Cable 0.5 m (1.6 ft.) + LEMO connector B Cable 2 m (6.6 ft.) + LEMO connector C Cable 2 m (6.6 ft.) + Banana plug connectors
H F G I S	Calibration certificate H Accredited calibration certificate (standard) F NPL traceable calibration certificate G NIST traceable calibration certificate I No certificate - Annealed only (Useless without calibration certificate / co-efficients) S Special calibration certificate

STS103B150AH Sample order number
Reference Pt100 150 mm., cable length 0.5 m (1.6 ft.) with LEMO termination and accredited certificate

STANDARD DELIVERY

- JOFRA STS-103 B probe
- Cable - according to order number
- Accredited certificate, points: -45, -20, 0, 50, 100, 200, 400°C
- Plastic carrying case with foam insert
- User manual

ACCESSORIES

65-PT100-LL-CABLE	Cable 2 m (6.6 ft.) + LEMO to LEMO
65-PT100-LB-CABLE	Cable 2 m (6.6 ft.) + LEMO to banana
122801	Cable 0.5 m (1.6 ft.) LEMO to LEMO

COMPATIBLE JOFRA INSTRUMENTS

The JOFRA STS-100 probes can be used with the following JOFRA instruments:

- JOFRA DTI-1000, spec. sheet no. SS-CP-2290
- JOFRA DTI050, spec. sheet no. SS-CP-2295
- JOFRA ATC series, spec. sheet no. SS-CP-2285
- JOFRA ASC300, spec. sheet no. SS-CP-2350
- JOFRA AMC900, spec. sheet no. SS-CP-2380

See the above-mentioned specification sheets and further information about the JOFRA instruments at www.jofra.com

ORDERING INFORMATION

Order no.	Description
ETC125A	Base model number ETC-125 A, -10 to 125°C / 14 to 257°F
ETC400A	ETC-400 A, 28 to 400°C / 82 to 752°F
ETC400R	ETC-400 R, 28 to 400°C / 82 to 752°C
	Power supply
115	ETC-400 A/R only: 115 VAC, 50/60 Hz
230	ETC-400 A/R only: 230 VAC, 50/60 Hz
MUL	ETC-125 A only: Multi voltage 115 and 230 VAC
	Mains power cable type
A	European, 230 V,
B	USA/Canada, 115 V
C	UK, 240 V
D	South Africa, 220 V
E	Italy, 220 V
F	Australia, 240 V
G	Denmark, 230 V
H	Switzerland, 220 V
I	Israel, 230 V
	Holes for sensor-under-test
01	Metric (12.5 mm, 6 mm, 4 mm, 8 mm)
02	Imperial (1/2 in, 3/8 in, 1/4 in, 5/32 in)
11	Imperial (1/16 in, 1/8 in, 5/32 in, 3/16 in, 1/4 in)
12	Imperial (1/16 in, 1/8 in, 3/16 in, 1/4 in, 3/8 in)
21	Metric (2 mm, 3 mm, 4 mm, 4 mm, 6 mm)
51	Infrared thermometers
	Calibration certificate
E	NPL and NIST traceable calibration certificate (standard delivery)
H	Accredited calibration certificate (on quotation basis)
	Options
C	Carrying case (standard for ETC-400 R)
X	No option used
ETC400A230A21EC	Sample order number JOFRA ETC-400 A series dry-block, 230 VAC power, European power cord, metric drilled multihole block, standard NPL/NIST traceable certificate and carrying case.



AMETEK Calibration Instruments offers a complete range of calibration equipment for temperature, pressure, and signal - including calibration software.

JOFRA Temperature Calibrators
Portable precision thermometer.
Dry-block and liquid bath calibrators: 4 series, with more than 20 models - featuring speed, portability, accuracy and advanced documenting functions with JOFRACAL temperature calibration software.

JOFRA Pressure Calibrators
Convenient electronic systems ranging from -1 to 700 bar (25 inHg to 10,000 psi) - multiple choices of pressure ranges, pumps and accuracies, fully temperature-compensated for problem-free and accurate field use.

JOFRA Signal Calibrators
Process signal measurement and simulation for easy control loop calibration and measurement tasks - from handheld field instruments for multi or single signals to laboratory reference level bench top instruments.

JOFRA / JF Marine Calibrators
A complete range of calibration equipment for temperature, pressure and signal, approved for marine use.

FP Temperature Sensors
A complete range of temperature sensors for industrial and marine use.

*...because calibration is
a matter of confidence*

AMETEK[®]
CALIBRATION INSTRUMENTS

AMETEK Calibration Instruments is one of the world's leading manufacturers and developers of calibration instruments for temperature, pressure and process signals as well as for temperature sensors both from a commercial and a technological point of view.

Headquarter:

AMETEK Denmark A/S
(Sales, Europe and the Middle East)
Gydevang 32-34 • 3450 Allerød • Denmark
Tel: +45 4816 8000 • ametek@ametek.dk

www.ametekcalibration.com
www.jofra.com

Information within this document is subject to change without notice.
©2005, by AMETEK, Inc., www.ametek.com. All rights reserved.

Pub code SS-CP-2280-US Issue 0610

Sales offices:

AMETEK T&C - Americas (Sales, The Americas)
Tel: +1 518 689 0222 • jofra.info@ametek.com

AMETEK Singapore Pte. Ltd. (Sales, Asia)
Tel: +65 6 484 2388 • aspl@ametek.com.sg

AMETEK Inc. Beijing Rep. Office (Sales, China only)
Tel: +86 10 8526 2111 • jofra@ametek.com.cn

AMETEK GmbH (Sales, Germany only)
Tel: +49 2159 91360 • info@ametek.de

AMETEK Lloyd Instruments (Sales, UK only)
Tel: +44 (0) 1489 486 404 • jofra@ametek.co.uk