

FLOWCOMPUTER

WITH TEMPERATURE AND PRESSURE
COMPENSATION FOR CORRECTED GAS VOLUME



Features

- Calculates compensated flow rate, total and accumulated total.
- Displays actual line pressure and temperature.
- Selectable on-screen engineering units; volumetric or mass.
- 7 digit resettable total.
- 11 digit accumulated total.
- Analog signal output.
- Very compact design for panel mount, wall mount or field mount applications.
- Operational temperature -30°C up to +80°C (-22°F up to 178°F).
- Rugged aluminum field mount enclosure IP67/NEMA4X.
- Intrinsically Safe
Ex II 1 GD EEx ia IIB/IIC T4 T100°C.
- Explosion/flame proof Ex II 2 GD EEx d IIB T5.
- Full Modbus communication RS232/485/TTL.
- Loop or battery powered, 8 - 24V AC/DC or 115 - 230V AC power supply.

Signal output

- (0)4 - 20mA / 0 - 10V DC according to compensated flow rate.

Signal input

Flow

- Reed-switch.
- NAMUR.
- NPN/PNP pulse.
- Sine wave (coil).
- Active pulse signals.
- (0)4 - 20mA.
- 0 - 10V DC.

Temperature

- PT100 - 2 or 3 wire.
- (0)4 - 20mA.
- 0 - 10V DC.

Pressure

- (0)4 - 20mA.
- 0 - 10V DC.

Applications

- Applications where nett gas flow calculation at base conditions is desired.

General information

Introduction

The flowcomputer Model F126-EG has been developed to calculate the gas volume at normal conditions for generic products, in most cases at 0°C (32 °F) and 1.013 Bar. If desired, any other temperature or pressure can be set. The corrected volumetric flow is calculated using the equations stored in the flowcomputer while a compressibility factor can be set to approach a real gas behaviour. A wide selection of options further enhance this models capabilities, including Intrinsic Safety and full Modbus communication.

Display

The display has large 17mm (0.67") and 8mm (0.31") digits which can be set to show flow rate, total, temperature and pressure. On-screen engineering units are easily configured from a comprehensive selection. The accumulated total can register up to 11 digits and is backed-up in EEPROM memory every minute.

Configuration

All configuration settings are accessed via a simple operator menu which can be pass-code protected. Each setting is clearly indicated with an alphanumerical description, therefore avoiding confusing abbreviations and baffling codes. Once familiar with one F-series product, you will be able to program all models in the series without a manual. All settings are safely stored in EEPROM memory in the event of sudden power failure.

Analog output signal

The calculated flow rate is re-transmitted with the (0)4 - 20mA or 0 - 10V DC output signal. The output signal is updated ten times per second with a filter function being available to smoothen out the signal if desired. The output value is user defined in relation to the flow rate, e.g. 4mA equals to 15Nm³/Hr and 20mA equals to 2000Nm³/Hr. The output signal can be passive, active or isolated where the passive output type will loop power the F126-EG as well.

Signal input

The flowcomputer measures the uncorrected volumetric flow, line temperature and pressure. The F126-EG will accept most pulse and analog input signals for flow. For the temperature measurement, 2 or 3 wire PT100 elements or sensors with a (0)4 - 20mA / 0 - 10V DC output signal can be used, just as for the pressure measurement.

Communication

All process data and settings can be read and modified manually or through the Modbus communication link (RS232 / RS485). Full Modbus functionality remains available for the Intrinsically Safe version (TTL).

Hazardous areas

For hazardous area applications, this model has been ATEX certified Intrinsically Safe Ex II 1 GD EEx ia IIB / IIC T4 T100°C with an allowed operational temperature of -30°C to +70°C (-22°F to +158°F). A flame proof enclosure is also available with the rating Ex II 2 GD EEx d IIB T5.

Enclosures

Various types of enclosures can be selected, all ATEX approved. As standard the F126-EG is supplied in an GRP panel mount enclosure, which can be converted to an IP67 / NEMA 4X GRP field mount enclosure by the addition of a back case. Most popular is our rugged aluminum field mount enclosure with IP67 / NEMA 4X rating. Both European or U.S. cable gland entry threads are available.

Overview application F126-EG

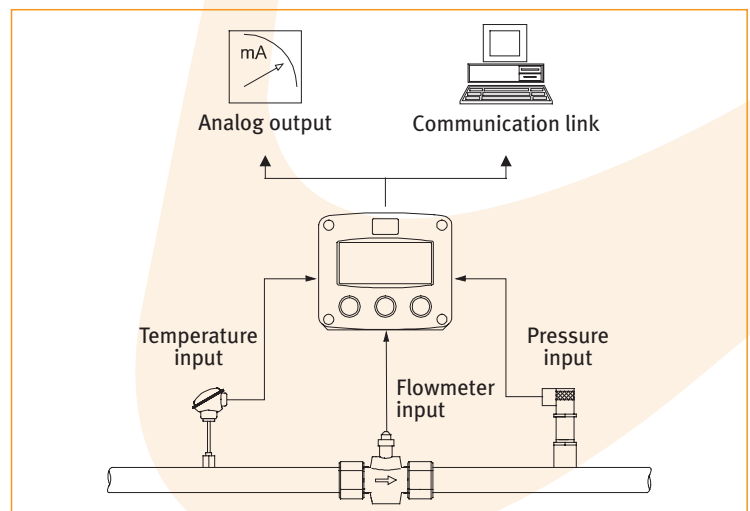

Dimensions enclosures Aluminum & GRP panel mount enclosure

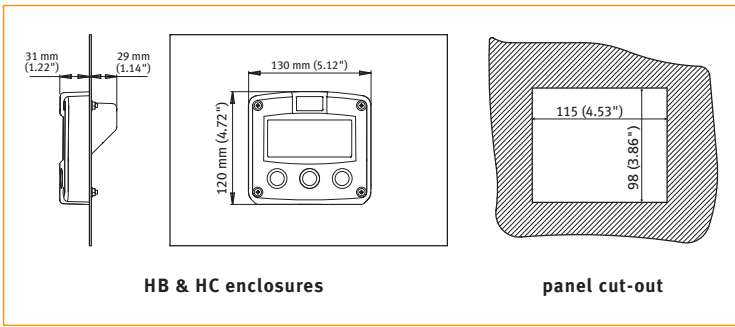

Aluminum & GRP field / wall mount enclosures

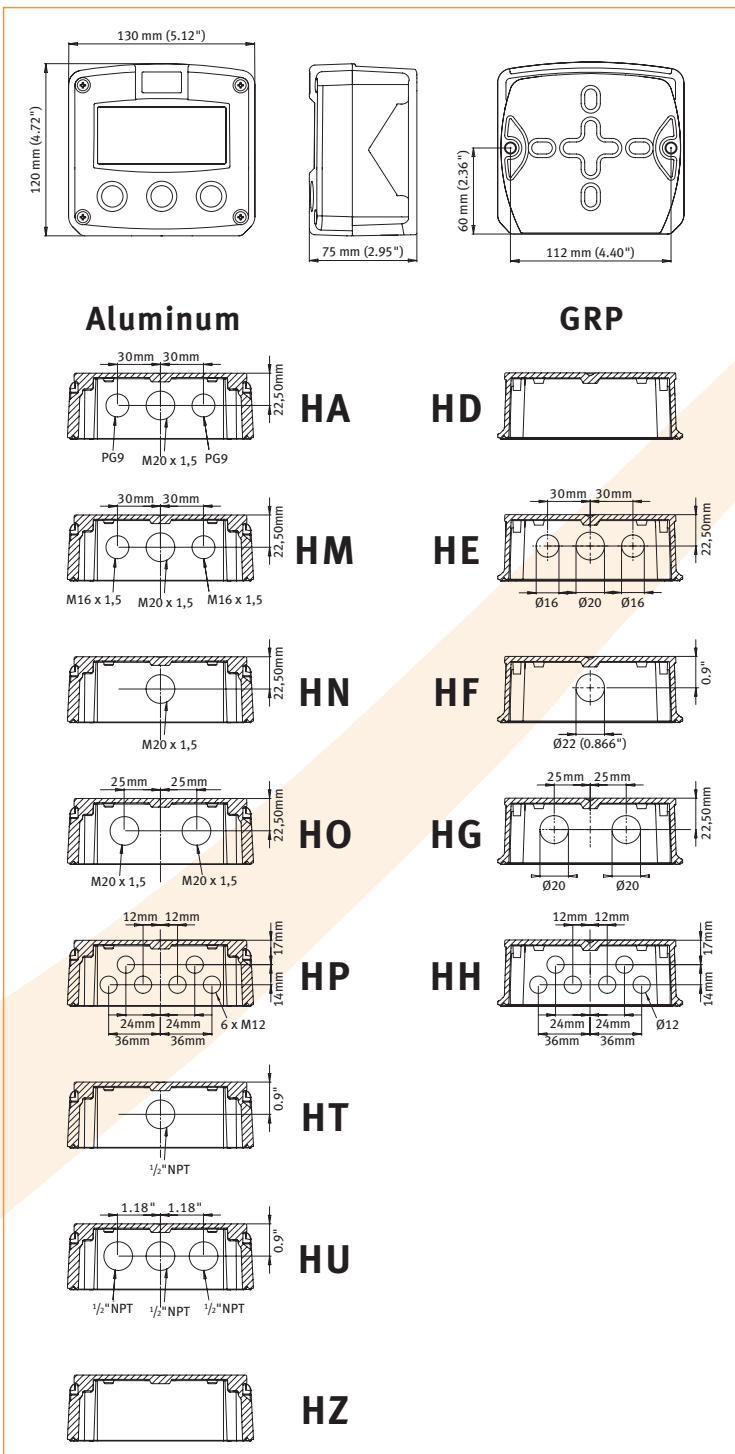

Terminal connections

POWER SUPPLY	COMMUNICATION / BACKLIGHT
GND 1 2	26 27 28 29 30 31
PD: 8 - 24V AC ~	CB: RS232 DTR +12V↑ RXD TXD
PD: 8 - 24V DC -	CH: RS485 - 2 wire A B
PD: XI: 16 - 30V DC +	CI: RS485 - 4 wire A B Y Z
PD: 115 - 230V AC ~	CT: TTL Intrinsically Safe DTR +12V↑ RXD TXD
PX: 8 - 30V DC Output loop powered unit with type AP (terminals GND - 1 - 2 are not available)	ZB: Backlight option - +↑ - +↑
PB / PC: battery powered Internal long life Lithium battery (terminals GND - 1 - 2 are not available)	(With PD / PE / PM terminals 26 / 31 are not available, backlight power supply is integrated.)
PI: input loop powered (terminals GND - 1 - 2 are not available)	
TEMPERATURE INPUT / PRESSURE INPUT	TEMPERATURE INPUT
17 18 19	20 21 22
IA: (0)4 - 20mA (with TA/TU)* I+↑ I-↓	TP: PT100 2-wire +↑ -↓
IU: 0 - 10V (with TA/TU)* U+↑ U-↓	TP: PT100 3-wire +↑ -↓
IA: (0)4 - 20mA (with TA/TU+PF/PM)** I+↑ I-↓	
IU: 0 - 10V (with TA/TU+PF/PM)** U+↑ U-↓	
TEMPERATURE INPUT / PRESSURE INPUT	TEMPERATURE INPUT / PRESSURE INPUT
12 13 14	15 16
TA: (0)4 - 20mA* I+↑ I-↓	
TU: 0 - 10V* U+↑ U-↓	
IA: (0)4 - 20mA (with TP)* I+↑ I-↓	
IU: 0 - 10V (with TP)* U+↑ U-↓	
FLOWMETER INPUT	FLOWMETER INPUT
9 10 11	
P: coil ~	
P: reed switch / NPN I+↑ I-↓	
P: PNP I-↓ I+↑	
P: reamur I-↓ I+↑	
P: active signal I+↑ I-↓	
A: (0)4 - 20mA I+↑ I-↓	
IU: 0 - 10V U+↑ U-↓	
A - PL: 4 - 20mA I+↑ I-↓	
ANALOG OUTPUT	ANALOG OUTPUT
7 8	
AA: 4 - 20mA I+↑ I-↓	
AB: 0 - 20mA I+↑ I-↓	
AF: 4 - 20mA I-↓ I+↑	
AI: 4 - 20mA I-↓ I+↑	
AP: 4 - 20mA I+↑ I-↓	
AU: 0 - 10V U+↑ U-↓	

* Note: If TA / TU is used then IA / IU use terminal 17 - 18 - 19.
If TP is used then IA / IU use terminal 12 - 13 - 14.
** Note: If PF / PM and TA / TU is used then IA / IU use terminal 17 only.

Typical wiring diagram F126-P-AP-CH-EG-IA-PX-TA

Typical wiring diagram F126-P-AI-CI-EG-IA-PD-TA

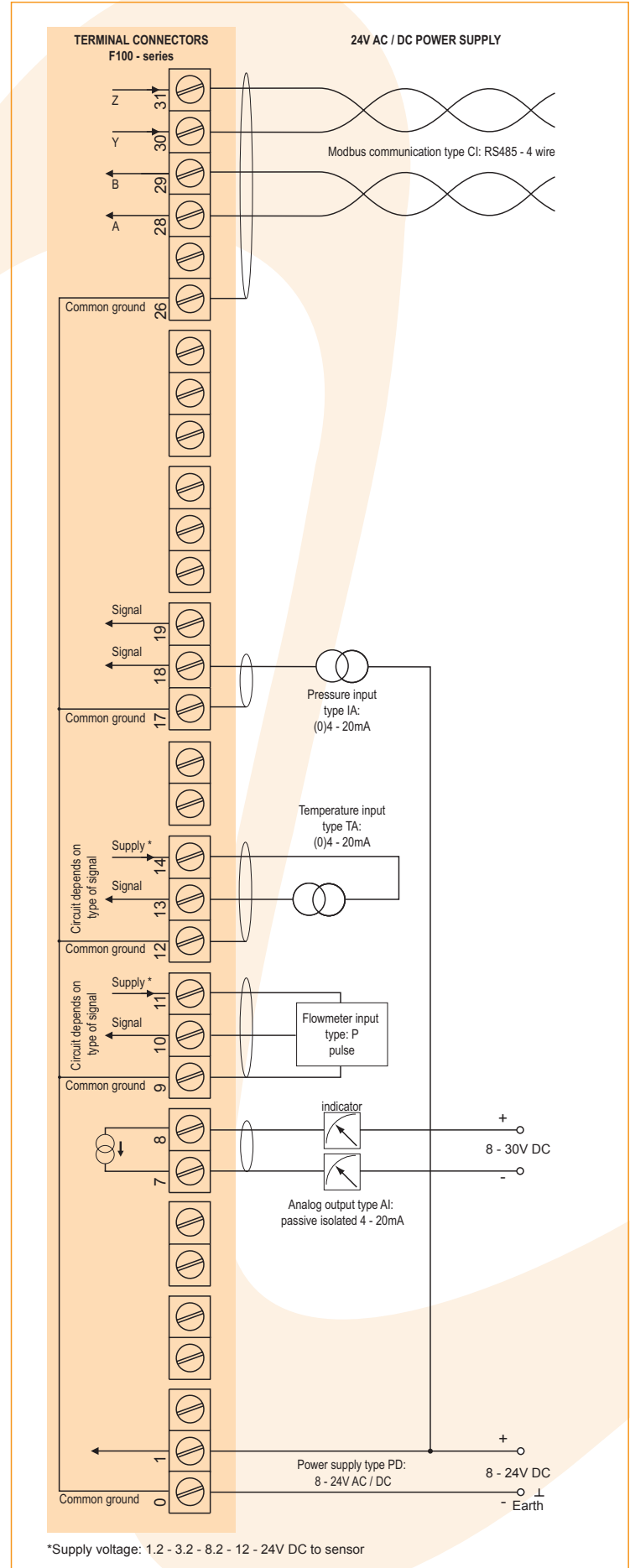
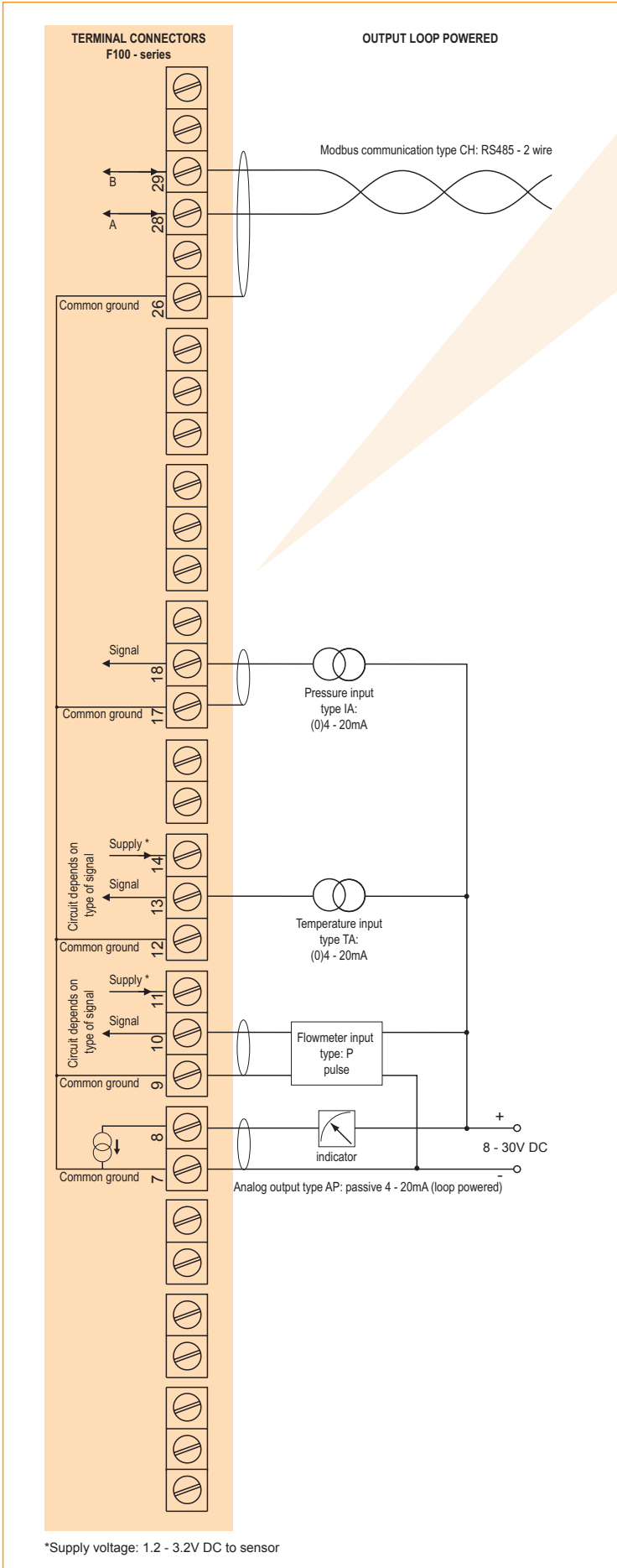

Typical wiring diagram F126-A-AA-CB-EG-IA-PM-TP

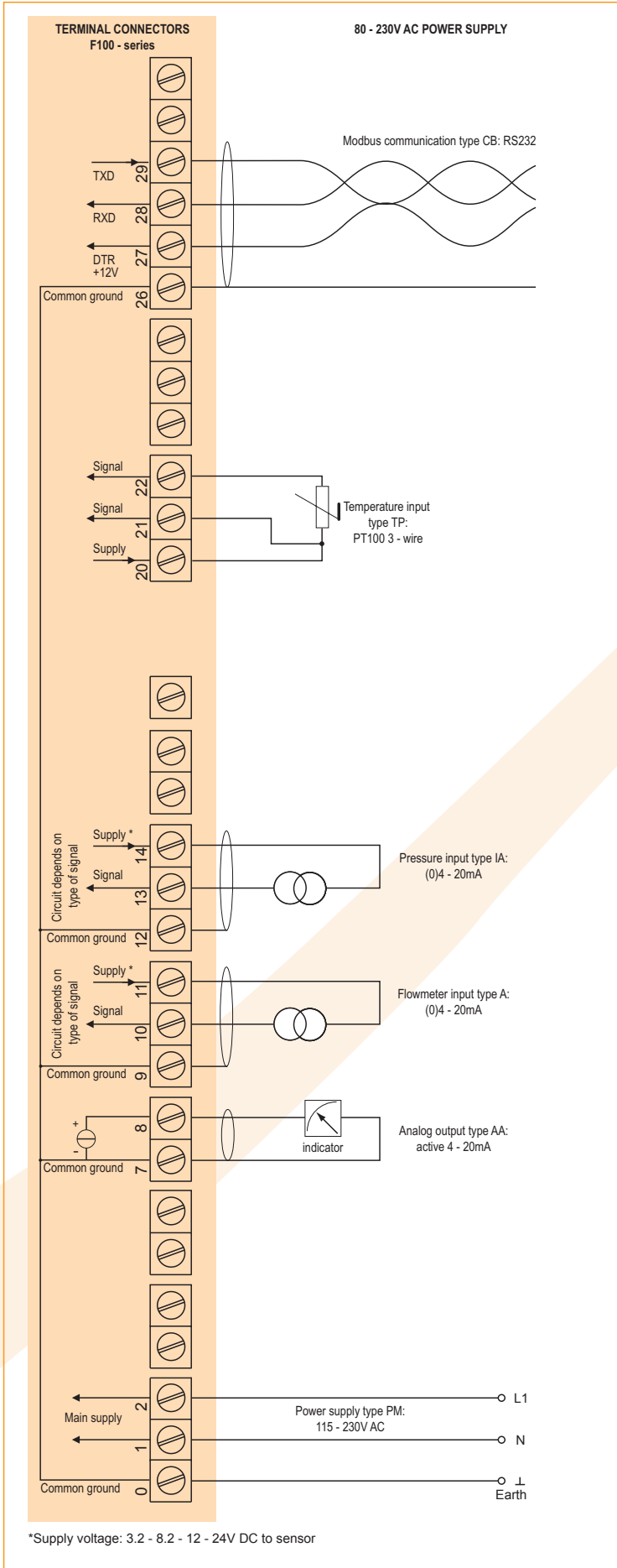

Typical wiring diagram F126-P-AI-CI-EG-IA-PM-TA

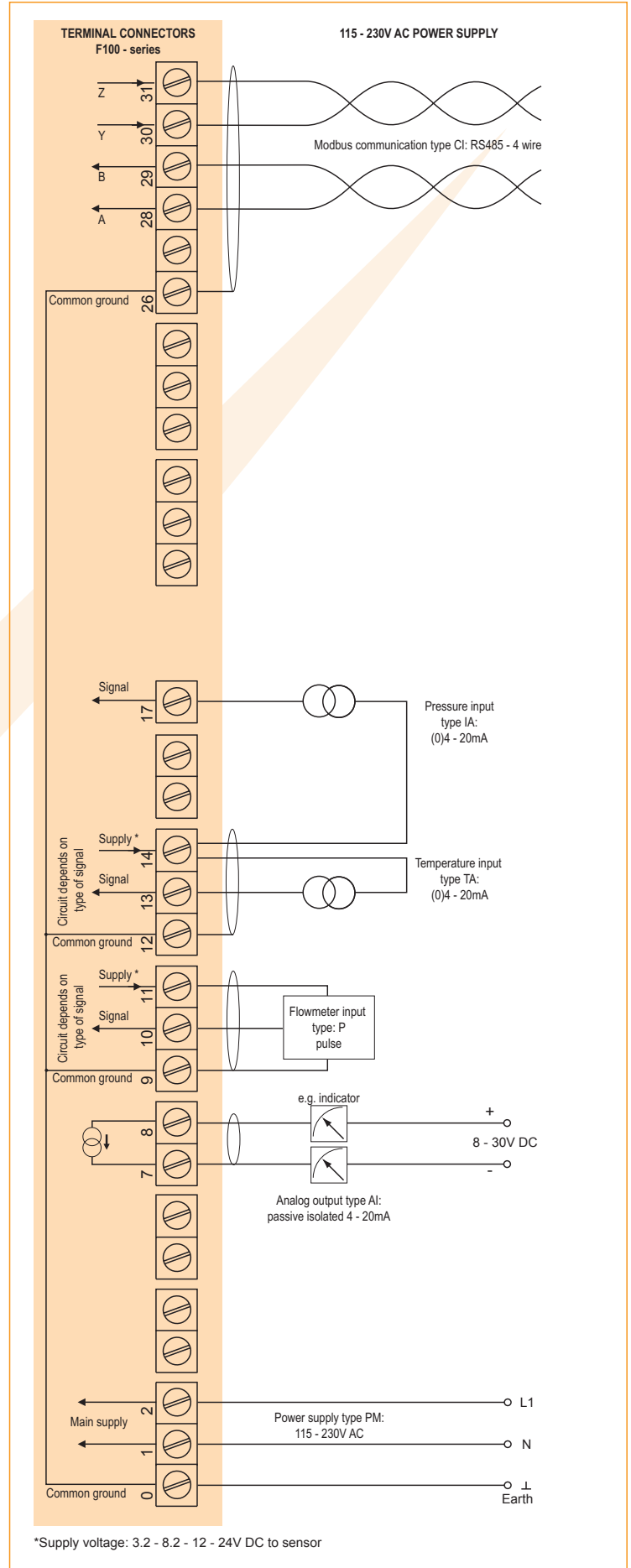

Hazardous area applications

The F126-EG-XI has been ATEX approved by KEMA for use in Intrinsically Safe applications. It is approved according to  II 1 GD EEx ia IIB/IIC T4 T100°C for gas and dust applications with an operational temperature range of -30°C to +70°C (-22°F to +158°F). It is allowed to connect up to five barriers in IIB applications or one barrier in IIC applications. Full functionality of the F126-EG remains available, including 4 - 20mA output according to the flow rate and Modbus communication (type CT). Power supply type PD-XI offers a 8.2V sensor supply e.g. for one Namur sensor and two analog sensors.

A flame proof enclosure with rating  II 2 GD EEx d IIB T5 is available as well. Please contact your supplier for further details.

Certificate of conformity KEMA 03ATEX1074 X



Configuration example IIB

F126-P-(AP)-(CT)-EG-IA-PC-TP-XI - Battery powered unit

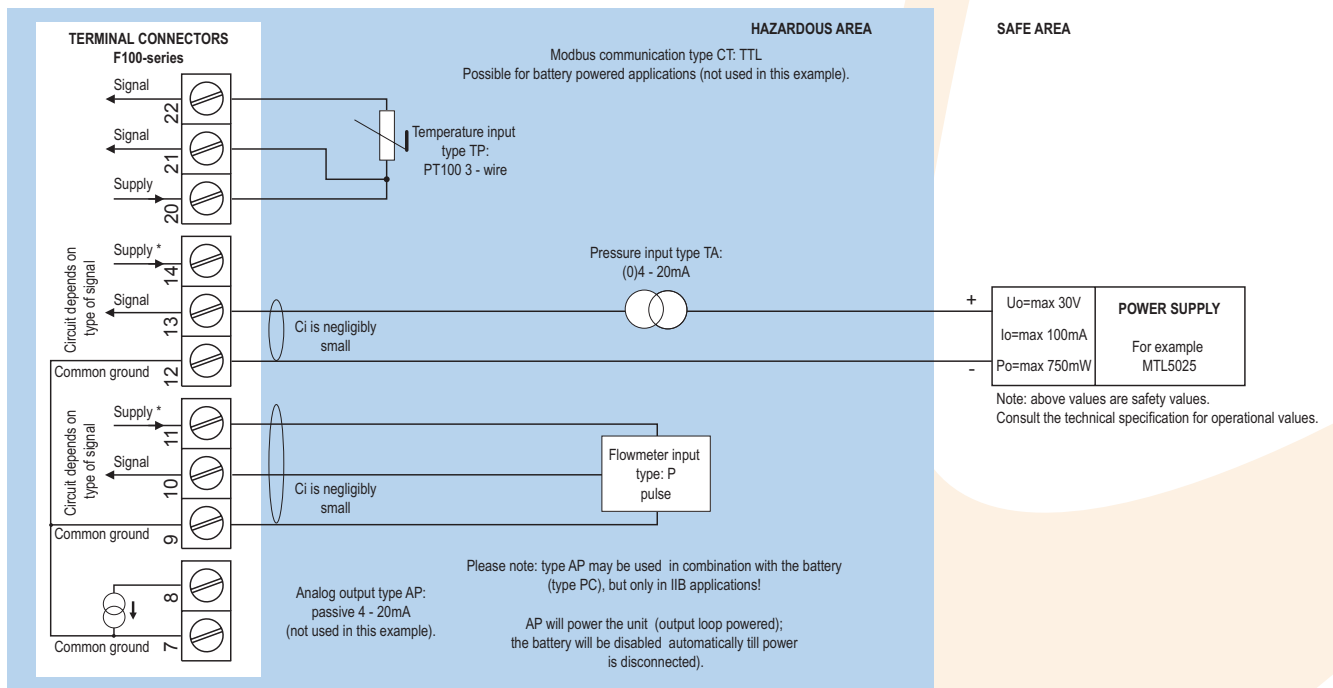

* Note sensor supply voltage: 1.2V DC for coil sensors or 3.2V DC for other pulse sensors.

Configuration example IIB - F126-P-AP-CT-EG-IA-PX-TP-XI - Output loop powered

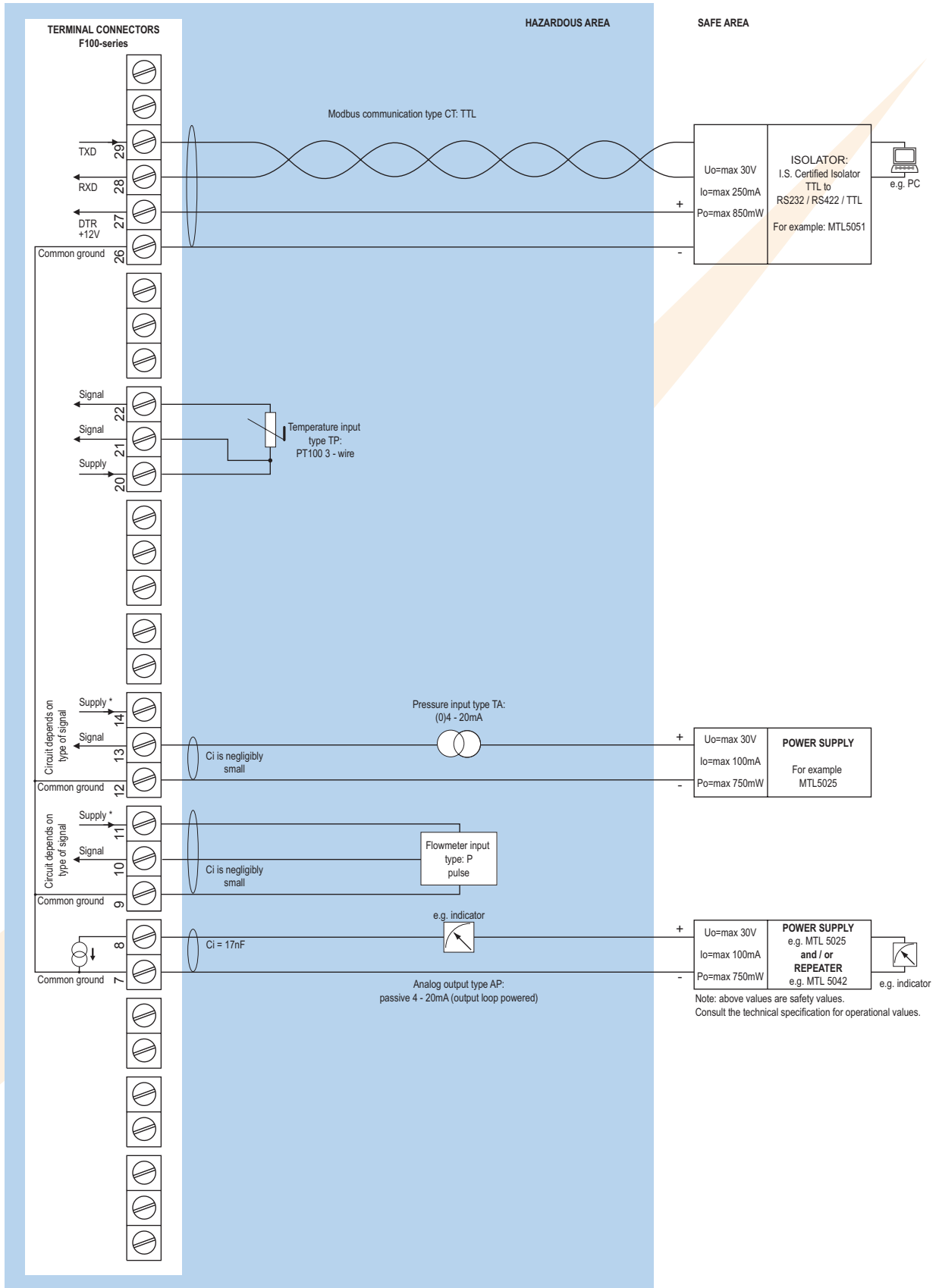

* Note sensor supply voltage: 1.2V DC for coil sensors or 3.2V DC for other pulse sensors.

Configuration example IIB and IIC - F126-A-AF-(CT)-EG-IA-PD-TA-XI - Power supply 16 - 30V DC

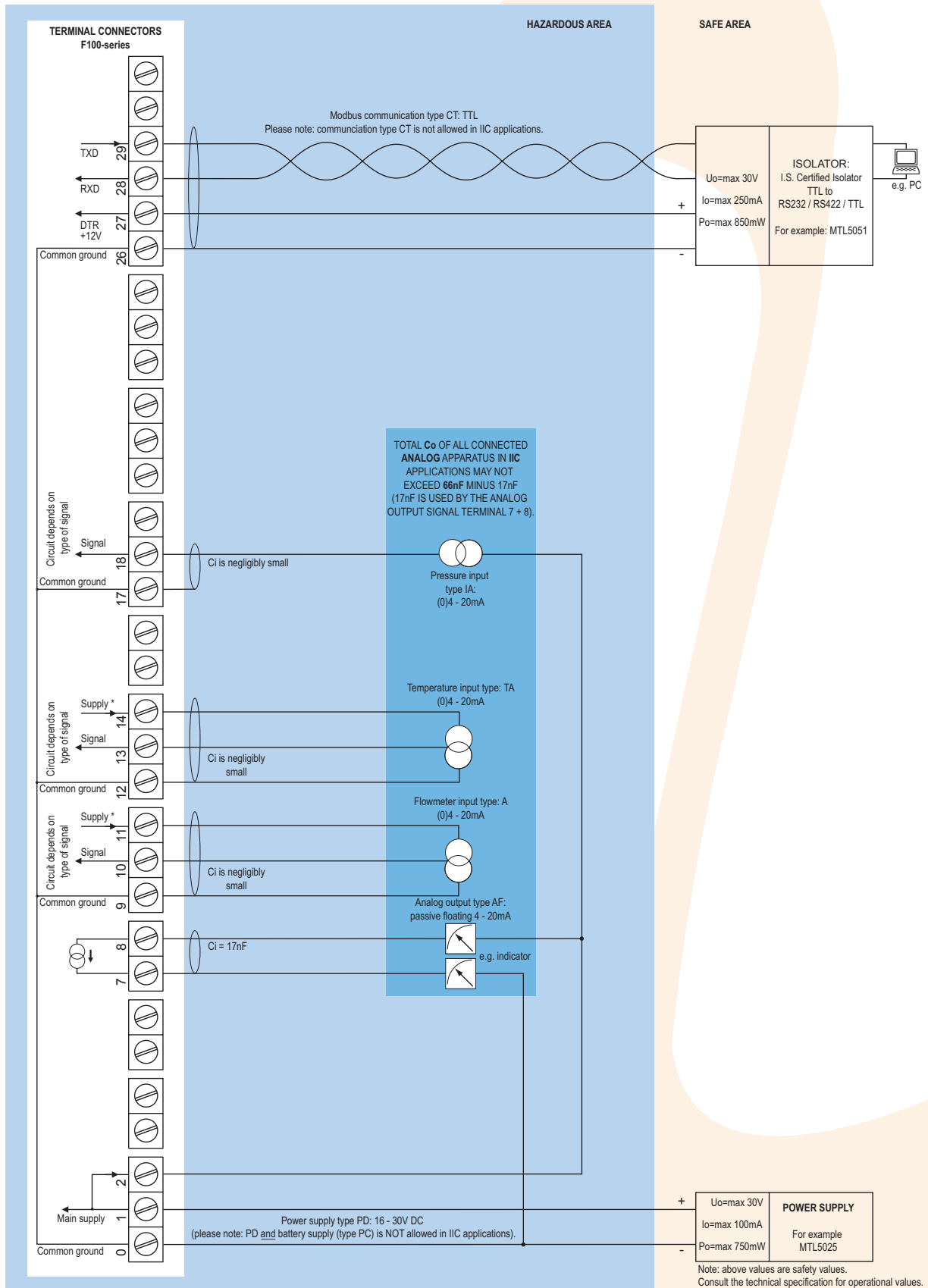

* Note power supply type PD: the supply voltage to pulse sensors is maximum 8.7V (U₀=max 8.7V I₀=max 25mA P₀=max 150mW) and to analog sensors as connected to terminal 1 (internally linked).

Configuration example IIB - F126-A-AF-CT-EG-IA-(PC)-(PD)-(PL)-TA-XI - Power supply 16 - 30V DC, battery or loop powered

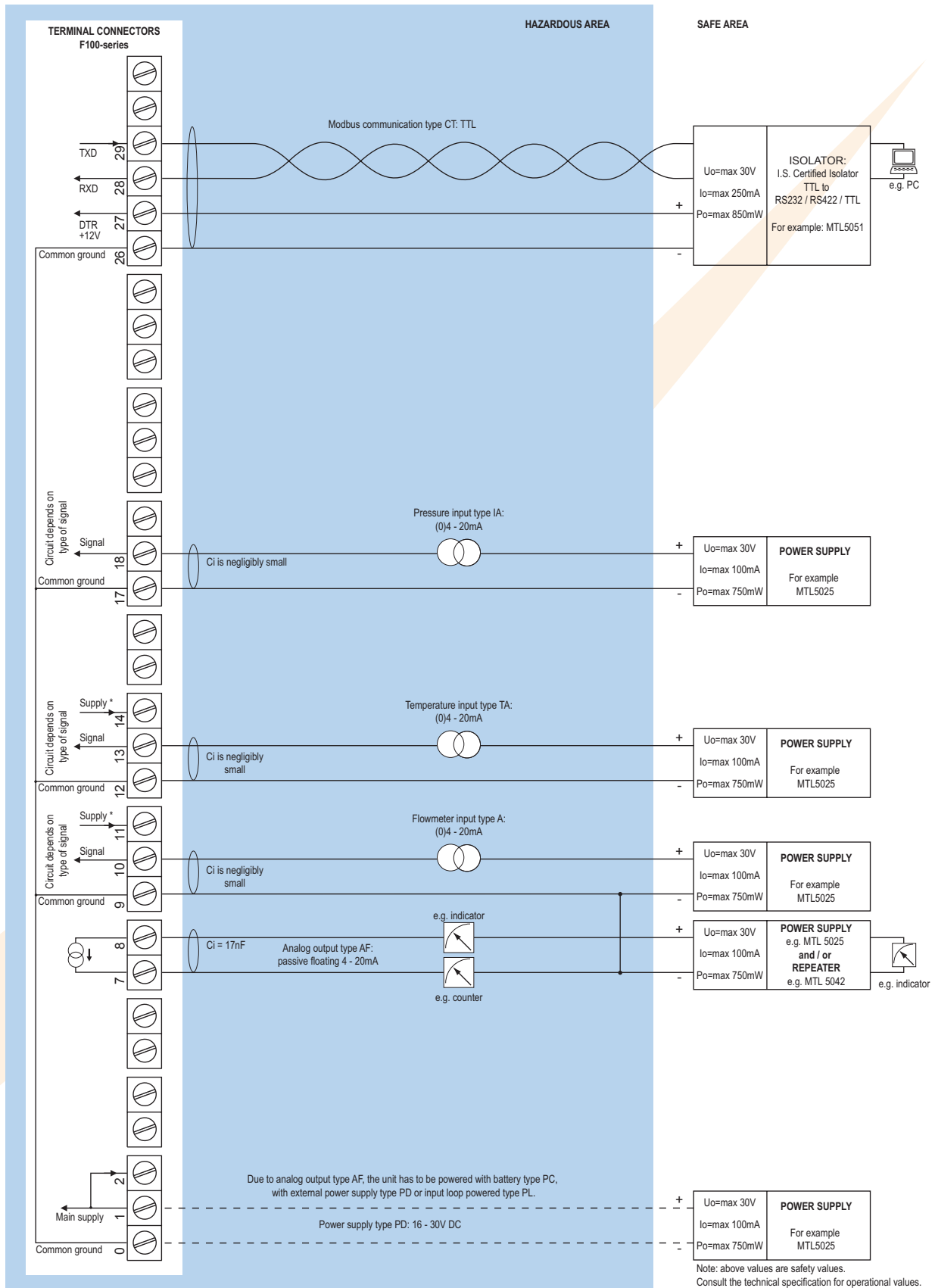

* Note power supply type PD: the supply voltage to pulse sensors is maximum 8.7V ($U_o = \max 8.7V$ $I_o = \max 25mA$ $P_o = \max 150mW$) and to analog sensors as connected to terminal 1 (internally linked).

Technical specification

General

Display	
Type	High intensity reflective numeric and alphanumeric LCD, UV-resistant.
Dimensions	90 x 40mm (3.5" x 1.6").
Digits	Seven 17mm (0.67") and eleven 8mm (0.31") digits. Various symbols and measuring units.
Refresh rate	User definable: 8 times/sec. - 30 secs.
Option ZB	Transflective LCD with green LED backlight. Good readings in full sunlight and darkness.
Note	Only available for safe area applications.

Operating temperature

Operational	-30°C to +80°C (-22°F to +178°F).
Intrinsically Safe	-30°C to +70°C (-22°F to +158°F).

Power requirements

Type PB	Long life Lithium battery - life-time depends upon settings and configuration - up to 5 years.
Type PC	Intrinsically Safe long life lithium battery - life-time depends upon settings and configuration - up to 5 years.
Type PD	8 - 24V AC / DC ± 10%. Power consumption max. 10 Watt. Intrinsically Safe: 16 - 30V DC; power consumption max. 0.75 Watt.
Type PF	24V AC / DC ± 10%. Power consumption max. 15 Watt.
Type PL	Input loop powered from sensor signal 4 - 20mA (type "A") - requires types AI or AF.
Type PM	115 - 230V AC ± 10%. Power consumption max. 15 Watt.
Type PX	8 - 30V DC. Power consumption max. 0.5 Watt.
Type ZB	12 - 24V DC ± 10% or type PD / PF / PM. Power consumption max. 1 Watt.
Note PB/PF/PM	Not available Intrinsically Safe.

Power requirements (continuation)

Note PF/PM	The total consumption of the sensors and outputs may not exceed 400mA @ 24V.
Note	For Intrinsically Safe applications, consult the safety values in the certificate.

Sensor excitation

Type PB/PC/PX	3.2V DC for pulse signals and 1.2V DC for coil pick-up.
Note	This is not a real sensor supply. Only suitable for sensors with a very low power consumption like coils (sine wave) and reed-switches.
Type PD	1.2 - 3.2 - 8.2 - 12 and 24V DC - max. 50mA @ 24V DC.
Type PD-XI	1.2 - 3.2 - 8.2V DC - max. 7mA @ 8.2V DC and mains power supply voltage (as connected to terminal 1).
Note	In case PD-XI and signal A or U: the sensor supply voltage is according to the power supply voltage connected to terminal 1. Also terminal 2 offers the same voltage.
Type PM	1.2 - 3.2 - 8.2 - 12 and 24V DC - max. 400mA @ 24V DC.

Terminal connections

Type	Removable plug-in terminal strip. Wire max. 1.5mm ² and 2.5mm ² .
------	---

Data protection

Type	EEPROM backup of all settings. Backup of running totals every minute. Data retention at least 10 years.
Pass-code	Configuration settings can be pass-code protected.

Environment

Electromagnetic compatibility	Compliant ref: EN 61326 (1997), EN 61010-1 (1993).
-------------------------------	--

Hazardous area

Intrinsically Safe Type XI	ATEX approval ref.: II 1 GD EEx ia IIB/IIC T4 T100°C. Maximum ambient +70°C (158°F).
Explosion proof Type XF	ATEX approval ref.: II 2 GD EEx d IIB T5. Dimensions of enclosure: 300 x 250 x 200mm (11.8" x 9.9" x 7.9") L x H x D.
Weight	appr. 15 Kg.

Casing

General

Window	Polycarbonate window.
Sealing	Silicone.
Control keys	Three industrial micro-switch keys. UV-resistant silicone keypad.
Option ZS	Silicone free ABS enclosure with EPDM and PE sealings. UV-resistant polyester keypad.
Note	This option comes with type HD only.

Aluminum wall / field mount enclosures

General	Die-cast aluminum wall/field mount enclosure IP67 / NEMA 4X with 2-component UV-resistant coating.
Dimensions	130 x 120 x 75mm (5.12" x 4.72" x 2.95") - W x H x D.
Weight	1064 gr.
Type HA	Cable entry: 2 x PG9 and 1 x M20.
Type HM	Cable entry: 2 x M16 and 1 x M20.
Type HN	Cable entry: 1 x M20.
Type HO	Cable entry: 2 x M20.
Type HP	Cable entry: 6 x M12.
Type HT	Cable entry: 1 x 1/2" NPT.
Type HU	Cable entry: 3 x 1/2" NPT.
Type HZ	Cable entry: no holes.

GRP wall / field mount enclosures

General	GRP wall/field mount enclosure IP67 / NEMA 4X, UV-resistant and flame retardant.
Dimensions	130 x 120 x 75mm (5.12" x 4.72" x 2.95") - W x H x D.
Weight	566 gr.
Type HD	Cable entry: no holes.
Type HE	Cable entry: 2 x Ø 16mm and 1 x Ø 20mm.
Type HF	Cable entry: 1 x Ø 22mm (0.866").
Type HG	Cable entry: 2 x Ø 20mm.
Type HH	Cable entry: 6 x Ø 12mm.

Panel mount enclosures

Dimensions	130 x 120 x 60mm (5.12" x 4.72" x 2.36") - W x H x D.
Panel cut-out	115 x 98mm (4.53" x 3.86") L x H.
Type HB	Die-cast aluminum panel mount enclosure IP65 / NEMA 4.
Weight	570 gr.
Type HC	GRP panel mount enclosure IP65 / NEMA 4, UV-resistant and flame retardant.
Weight	422 gr.

Signal inputs

Pressure

Accuracy	Resolution: 14 bit. Error < 0.025mA / ± 0.125% FS. Low level cut-off programmable.
Update time	Four times per second.
Type IA	(0)4 - 20mA. Analog input signal can be scaled to any desired range within 0 - 20mA.
Span	0.000010 - 9,999,999 with variable decimal position.
Offset	0.000 - 9,999.999.
Voltage drop	2.5V @ 20mA.
Type IU	0 - 10V DC. Analog input signal can be scaled to any desired range within 0 - 10V DC.
Span	0.000010 - 9,999,999 with variable decimal position.
Load impedance	3kΩ.
Note	For signal type IA and IU: external power to sensor required; e.g. PD.

Flowmeter

Type P	Coil / sine wave (minimum 20mVpp or 80mVpp - sensitivity selectable), NPN/PNP, open collector, reed-switch, Namur, active pulse signals 8 - 12 and 24V DC.
Frequency	Minimum 0Hz - maximum 7kHz for total and flow rate. Maximum frequency depends on signal type and internal low-pass filter. E.g. reed switch with low-pass filter: max. frequency 120Hz.
K-Factor	0.000010 - 9,999,999 with variable decimal position.
Low-pass filter	Available for all pulse signals.
Option ZF	coil sensitivity 10mVpp.
Type A	(0)4 - 20mA. Analog input signal can be scaled to any desired range within 0 - 20mA.
Type U	0 - 10V DC. Analog input signal can be scaled to any desired range within 0 - 10V DC.
Accuracy	Resolution: 14 bit. Error < 0.025mA / ± 0.125% FS. Low level cut-off programmable.
Span	0.000010 - 9,999,999 with variable decimal position.
Update time	Four times per second.
Voltage drop	Type A: 2.5V @ 20mA.
Load impedance	Type U: 3kΩ.
Relationship	Linear and square root calculation.
Note	For signal type A and U: external power to sensor is required; e.g. type PD.

Temperature

Accuracy	Resolution: 14 bit. Error < 0.025mA / ± 0.125% FS. Low level cut-off programmable.
Update time	Four times per second.
Type TA	(0)4 - 20mA. Analog input signal can be scaled to any desired range within 0 - 20mA.
Span	0.000010 - 9,999,999 with variable decimal position.
Offset	0.00 - 99,999.99 K.
Voltage drop	2.5V @ 20mA.
Type TP	2 or 3 wire PT100.
Range	-100°C to +200°C (-148°F to 392°F). Accuracy 0.1°C (0.18°F).
Option ZV	Range: -200°C to +800°C (-328°F to 1832°F). Accuracy 0.5°C (0.9°F).
Type TU	0 - 10V DC. Analog input signal can be scaled to any desired range within 0 - 10V DC.
Span	0.000010 - 9,999,999 with variable decimal position.
Offset	0.00 - 99,999.99 K.
Load impedance	3kΩ.
Note 1	For signal TA and TU: power supply to temperature sensor is required; e.g. PD.

Signal outputs

Analog output

Function	Transmitting compensated flow rate.
Accuracy	10 bit. Error < 0.05%. Analog output signal can be scaled to any desired range.
Update time	Ten times per second.
Type AA	Active 4 - 20mA output (requires PD or PM).
Type AB	Active 0 - 20mA output (requires PD or PM).
Type AF	Passive floating 4 - 20mA output for Intrinsically Safe applications (requires PC, PL or PD).
Type AI	Passive galvanically isolated 4 - 20mA output - also available for battery powered models (requires PB, PD, PL or PM).
Type AP	passive 4 - 20mA output - not isolated. Unit will be loop powered.
Type AU	Active 0 - 10V DC output (requires PD or PM).

Communication option

Function	Reading display information, reading / writing all configuration settings.
Protocol	Modbus RTU.
Speed	1200 - 2400 - 4800 - 9600 baud.
Addressing	Maximum 255 addresses.
Type CB	RS232
Type CH	RS485 2-wire
Type CI	RS485 4-wire
Type CT	TTL Intrinsically Safe.

Operational

Operator functions

Displayed functions	<ul style="list-style-type: none"> Compensated flow rate. Compensated total and accumulated total. Actual line temperature. Actual line pressure Total can be reset to zero by pressing the CLEAR-key twice.
---------------------	---

Total

Digits	7 digits.
Units	L, m ³ , GAL, USGAL, KG, lb, bbl, no unit.
Decimals	0 - 1 - 2 or 3.
Note	Total can be reset to zero.

Accumulated total

Digits	11 digits.
Units / decimals	According to selection for total.
Note	Can not be reset to zero.

Flow rate

Digits	7 digits.
Units	mL, L, m ³ , Gallons, KG, Ton, lb, bl, cf, RND, ft ³ , scf, Nm ³ , NL, ical - no units.
Decimals	0 - 1 - 2 or 3.
Time units	/sec - /min - /hr - /day.

Line temperature

Digits	6 digits.
Units	°C, °F or K.
Decimals	1.

Line pressure

Digits	6 digits.
Units	mbar, bar, PSI, no-unit.
Decimals	1.

Flow equations

Type EG	Corrected gas volume.
Formula	$Q_{\text{normal}} = Q \times \left(\frac{P}{P_{\text{normal}}} \right) \times \left(\frac{T_{\text{normal}}}{T} \right) \times \left(\frac{C_{\text{normal}}}{C} \right)$
Normal pressure	Default: 1.013 bar.
Normal temperature	Default: 273.15K (0°C / 32°F)



Display example - 90 x 40mm (3.5" x 1.6")

TOTAL	▲	139785.3	m ³
RATE	RUN	1853	NM ³ /HR



Ordering information Standard configuration: F126-P-AP-CX-EG-HC-IA-PX-TA-XX-ZX.

Ordering information: F126 - _ -A _ -C _ -EG -H _ -I _ -P _ -T _ -X _ -Z _



Flowmeter input signal

- A  (o)4 - 20mA input.
- P  **Pulse input: coil, npn, pnp, namur, reed-switch.**
- U  0 - 10V DC input.

Analog output signal

- AA Active 4 - 20mA output - requires PD or PM.
- AB Active 0 - 20mA output - requires PD or PM.
- AF  I.S. floating 4 - 20mA output - requires PC, PL or PD.
- AI Isolated 4 - 20mA output - requires PB, PD, PL or PM.
- AP  **Passive 4 - 20mA output, loop powered unit.**
- AU Active 0 - 10V DC output - requires PD or PM.



Communication

- CB Communication RS232 - Modbus RTU.
- CH Communication RS485 - 2wire - Modbus RTU.
- CI Communication RS485 - 4 wire - Modbus RTU.
- CT  Intrinsically Safe TTL - Modbus RTU.
- CX  **No communication.**





Flow equations

- EG  **Corrected gas volume.**









Panel mount enclosures - IP65 / NEMA4

- HB  Aluminum enclosure.
- HC  **GRP enclosure.**



GRP field / wall mount enclosures - IP67 / NEMA4X

- HD  Cable entry: no holes.
- HE  Cable entry: 2 x 16mm + 1 x 20mm.
- HF  Cable entry: 1 x 22mm (0.866").
- HG  Cable entry: 2 x 20mm.
- HH  Cable entry: 6 x 12mm.





Aluminum field / wall mount enclosures - IP67 / NEMA4X

- HA  Cable entry: 2 x PG9 + 1 x M20.
- HM  Cable entry: 2 x M16 + 1 x M20.
- HN  Cable entry: 1 x M20.
- HO  Cable entry: 2 x M20.
- HP  Cable entry: 6 x M12.
- HT  Cable entry: 1 x 1/2" NPT.
- HU  Cable entry: 3 x 1/2" NPT.
- HZ  Cable entry: no holes.



Pressure input

- IA  (o)4 - 20mA input.
- IU  0 - 10V DC input.



Power supply

- PB Lithium battery powered.
- PC  Lithium battery powered - Intrinsically Safe.
- PD  8 - 24V AC/DC + sensor supply - with XI: 16 - 30V DC.
- PL  Input loop powered from sensor signal type "A" - requires AI or AF and OT.
- PM 115 - 230V AC + sensor supply.
- PX  **Basic power supply 8 - 30V DC (no real sensor supply). Unit requires external loop AP.**





Temperature input

- TA  (o)4 - 20mA input.
- TP  PT100 input.
- TU  0 - 10V DC input.

Hazardous area

- XI  Intrinsically Safe.
- XF  EExd enclosure - 3 keys.
- XX **Safe area only.**

Other options

- ZB Backlight.
- ZF  Coil input 10mVpp.
- ZS  Silicone free ABS enclosure with EPDM and PE sealings (type HD only).
- ZV  PRTD-range -200°C / +800°C.
- ZX  **No options.**

The bold marked text contains the standard configuration.

 Available Intrinsically Safe.

Specifications are subject to change without notice.