

MODBUS[®] SERIAL INPUT METER

Snooper Model PD865



- RS-485 Modbus[®] RTU input
- Six full digits 999,999
- Sunlight readable LED display
- Scale in engineering units
- 16-point linearization
- Square root & programmable exponent
- Exact display of input data
- 4-20 mA analog output option
- Two Form A 3 A relays standard
- Two Form C 3 A relays option
- Up to four pump alternation control
- Universal power supply

Keep it Simple

Keep it Digital



APPLICATIONS

Master or Slave

The PD865 Snooper Modbus Serial Input Meter can be programmed as a Modbus RTU Master or Slave. As a Master, the Snooper reads a slave device, scales the data from it, displays the result, and operates the internal relays and 4-20 mA output. As a Slave, it is controlled by a master device. The data sent to it by the master is scaled, displayed, and used to operate the relays and 4-20 mA output.

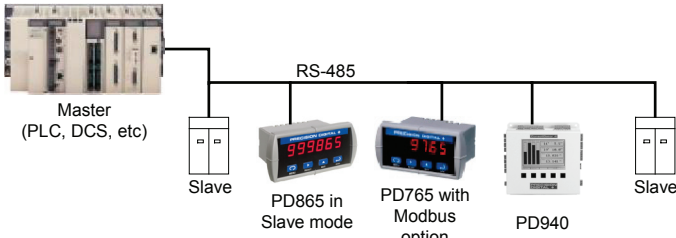

PD865 Connected to a Master

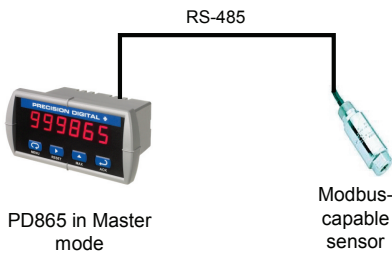

PD865 Connected to a Smart Sensor

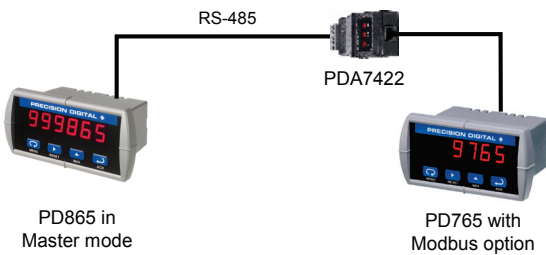

PD865 Connected to a PD765 Trident

Alternate up to Four Pumps

The Snooper, in conjunction with a Modbus output level transmitter, can be used to control and alternate up to four pumps. In the application below, the Snooper's two Form C relays are being used to control and alternate the Main and Backup pumps, and the Snooper's two Form A relays are being used for High and Low Alarm.

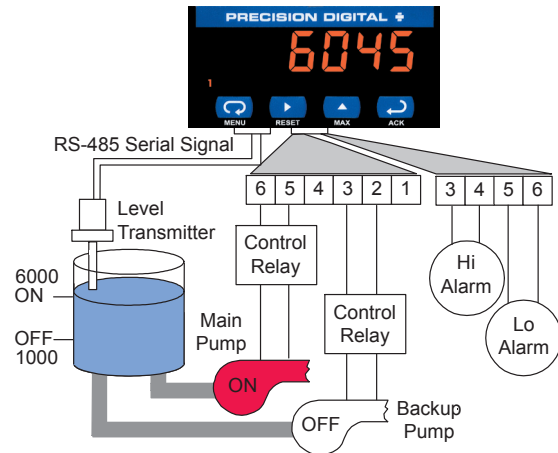

Multi-Point Linearization

The Snooper's multi-point linearization feature can be used to display the volume in a round horizontal tank or any other non-linear vessel. In addition, it can generate a 4-20 mA output that is linear to volume.

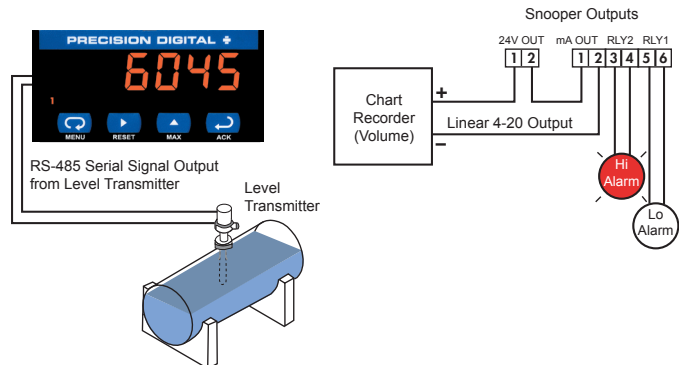

FIELD ENCLOSURES

The Snooper is available with a wide variety of NEMA 4, NEMA 4X, and explosion-proof enclosures.

Low-Cost Plastic NEMA 4X Enclosure

The PDA2801 is a low-cost, compact, plastic NEMA 4X enclosure that will house one Snooper.



Plastic, Steel & Stainless Steel



Optional NEMA 4 & 4X enclosures house from one to ten meters and feature a hinged door.

Enclosures and meters are ordered and packaged separately.

Engraved Plastic Labels

Optional custom engraved plastic labels are the perfect solution for identifying both the enclosure and each individual meter.

Whether the meters are mounted in one of our enclosures or installed into your existing control panel these custom engraved plastic labels are the answer you're looking for!

CONNECTIONS

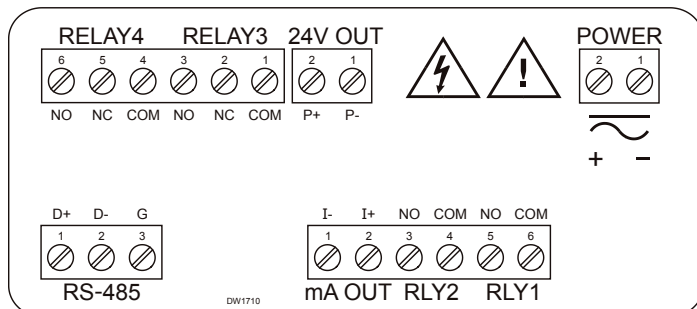

ORDERING INFORMATION

Snooper Model PD865		
85-265 VAC**	12-36 VDC**	Options Installed
Model	Model	
PD865-6R2-06		None
PD865-6R5-16		4-20 mA Output & 24 VDC Transmitter Supply
PD865-6R7-16		2 Relays, 4-20 mA Output & 24 VDC Transmitter Supply
	PD865-7R5-06	4-20 mA Output
	PD865-7R7-06	2 Relays & 4-20 mA Output

All models are supplied with 2 Form A relays.
**May be powered from AC or DC, see Specifications for details.

Accessories	
Model	Description
PDA7485-I	RS-232 to RS-422/485 Isolated Converter
PDA7485-N	RS-232 to RS-422/485 Non-Isolated Converter
PDA8485-I	USB to RS-422/485 Isolated Converter
PDA8485-N	USB to RS-422/485 Non-Isolated Converter
PDX6901	Suppressor (snubber): 0.01 μ F/470 Ω , 250 VAC
PDLXXXX	Engraved Plastic Labels

Services	
Model	Description
PDN-CAL	Calibration with Certificate
PDN-CALDATA	Calibration with Certificate & Data
PDN-LTCAL5	Lifetime Annual Recertification (shipped back within 5 days)
PDN-CSETUP	Custom Setup
PDN-EXTWRNTY1-0	Ext. Warr. 1 Year LP:\$0-\$299
PDN-EXTWRNTY1-1	Ext. Warr. 1 Year LP:\$300-\$599
PDN-EXTWRNTY2-0	Ext. Warr. 2 Years LP:\$0-\$299
PDN-EXTWRNTY2-1	Ext. Warr. 2 Years LP:\$300-\$599

MOUNTING DIMENSIONS

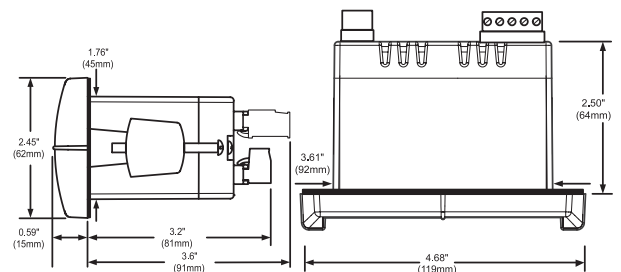

Notes:

1. Panel cutout required: 1.772 x 3.622 (45 x 92)
2. Panel thickness: 0.040 - 0.250 (1.0 - 6.4)
3. Mounting brackets lock in place for easy mounting

SPECIFICATIONS

Except where noted all specifications apply to operation at +25°C.

General

Input/Output: Modbus RTU RS-485

Display: 0.56" (14.2 mm) red LED, 6 digits; displays from -199999 to 999999, automatic leading zero blanking

Display Intensity: Eight user selectable intensity levels

Decimal Point: Up to five decimal places: d.ddddd, dd.dddd, ddd.d, dddd.dd, ddddd.d, or dddddd

Front Panel: NEMA 4X, IP65; panel gasket provided

Programming Methods: Four front panel buttons or via Modbus registers (Slave mode only)

Scaling: Input may be scaled from -199,999 to 999,999

Function: Linear, square root, or programmable exponent from 0.50000 to 2.99999

Multi-Point Linearization: 2 to 16 points

Noise Filter: Programmable 2 to 199 (0 will disable filter)

Bypass: 0.2 to 99.9% of full-scale

Cutoff: 0 to 999999; 0 disables cutoff

Display Update Rate: Master: 10/sec to 1 every 25.5 seconds; Slave: Dependent on master device (PLC, DCS, etc)

Overrange: Display flashes 999999

Underrange: Display flashes -199999

Max/Min Display: Stored until reset by user or meter is turned off; user can reset by front panel buttons or via Modbus registers.

Password: Restricts modification of programmed settings.

Non-Volatile Memory: Settings stored for a minimum of 10 years.

Power Options: 85-265 VAC, 50/60 Hz; 90-265 VDC, 20 W max or 12-36 VDC; 12-24 VAC, 6 W max.

Required Fuse: UL Recognized, 5 A max, slow-blow; up to 6 meters may share one fuse.

Normal Mode Rejection: 64 dB at 50/60 Hz

Transmitter Supply: Isolated 24 VDC ±10% @ 200 mA max

Isolation: 4 kV input/output-to-power line, 500 V input-to-output or output-to-24 VDC supply

Operating Temperature: 0 to 65°C

Storage Temperature: -40 to 85°C

Relative Humidity: 0 to 90% non-condensing

Connections: Removable screw terminals accept 12 to 26 AWG

Enclosure: 1/8 DIN, high impact plastic, UL 94V-0, color: gray

Weight: 9.7 oz (275 g) (including options)

UL File Number: E160849; 508 Industrial Control Equipment

Warranty: 3 years parts & labor

Extended Warranty: 1 or 2 years, refer to Price List for details.

Operating Modes

Master: Processes data read from a Modbus RTU slave device (only one parameter at a time can be programmed for reading).

Slave: Processes data sent from a Modbus RTU master device.

Note that the relays and the 4-20 mA output are functional in either mode.

Master Mode Settings

Function Code: Select which Modbus function code (03 or 04) to use in reading the slave device.

Register Number: 1 to 65536. Specifies which register(s) to read in the slave device. Register number is preceded by register type (3xxxxx or 4xxxxx). Five or six digit register number allowed.

Data Type: Select the data format that the slave device uses; select between Short (2 byte) and Long (4 byte), Integers or Floating point (4 byte), Signed or Unsigned (integer only), and byte order (big-endian vs little-endian).

Slave Response Timeout: 0 to 25.5 seconds, limited by Poll Time value. This is the time allowed for slave to respond to a command.

Poll Time: 0.1 to 25.5 seconds between read commands.

Relays

Rating: 2 Form A (SPST) standard; 2 Form C (SPDT) optional; rated 3 A @ 30 VDC or 3 A @ 250 VAC, resistive loads

High or Low Alarm: User may program any alarm for high or low

Deadband: 0-100% FS, user selectable

Relay Operation:

1. Automatic (non-latching)
 2. Latching
 3. Pump alternation control (up to 4 relays)
- Relay Reset:** Selectable via front panel or Modbus registers
1. Automatic reset only (non-latching)
 2. Automatic plus manual reset at any time (non-latching)
 3. Manual reset only, at any time (latching)
 4. Manual reset only after alarm condition has cleared (latching)

Automatic Reset: Relays reset when input passes the reset point

Manual Reset: Front panel button, Modbus registers (Slave only)

Time Delay: 0 to 199 seconds, on and off delays, programmable and independent for each relay

Fail-Safe Operation: Programmable, independent for each relay

Communications Break: No change, Relay on, or Relay off. Controls the condition the relay goes to when a slave device does not reply (Master mode only).

Auto Initialization: When power is applied to the meter, relays will reflect the state of the input to the meter.

Serial Communications

Compatibility: EIA-485

Protocol: Modbus RTU

Address: 1 to 247. Specifies the address of the slave device (Master mode) or the address of the PD865 (Slave mode).

Baud Rate: 300 to 19,200 bps

Data: 8 bits (1 start bit, 1 stop bit; 1 or 2 stop bits with no parity)

Parity: None, even, or odd

Byte-to-Byte Timeout: 0.01 to 2.54 seconds

Turn Around Delay: Less than 2 ms (fixed)

Isolated 4-20 mA Transmitter Output

Scaling Range: 1.000 to 23.000 mA; reverse scaling allowed.

Calibration: Factory calibrated 4.000 to 20.000 mA

Accuracy: ±0.1% FS ±0.004 mA

Recalibration: Recommended at least every 12 months.

Temperature Drift: 50 PPM/°C

Transmitter Supply: Isolated 24 VDC ±10% @ 200 mA max

Isolation: 500 V input-to-output or output-to-24 VDC supply; 4 kV output-to-power line

External Loop Power Supply: 35 VDC maximum

Output Loop Resistance:

Power Supply	Loop Resistance	
	Minimum	Maximum
24 VDC	10 Ω	700 Ω
35 VDC (external)	100 Ω	1200 Ω

Data Source: Display value, maximum display value, minimum display value, or Modbus register

Overrange: Programmable mA output for overrange condition

Underrange: Programmable mA output for underrange condition

Communications Break: Programmable mA output when a slave device does not reply within the Slave Response Timeout

Maximum Output: Programmable absolute maximum mA output

Minimum Output: Programmable absolute minimum mA output

LDS865_B 02/07